

Effio-v™

700TVL

REAL WDR/3DNR/DEFOG/IR OPTIMIZE/ SCENE SELECTION

IR BULLET CAMERA

USER'S MANUAL

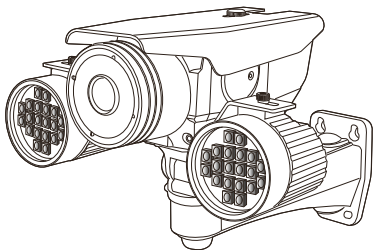

- Sony 960H Double Scan CCD II
- Horizontal Resolution of over 700 TV-Line
- LED : IR LED 40 + SRLED 40units / IR LED 40 units
- Night View Distance : 120m / 40m
- External Control : Focus/Zoom(Gear Type), OSD Control, Service Video
- Real Wide Dynamic Range
- True Day & Night(ICR)
- 2D&3D Noise Reduction
- IR-Optimizer
- Digital Image Stabilizer
- Defog(Auto. Detection)
- Motion Detection (Frame rate link)
- Multi-languages OSD
- Polygon Privacy mask
- Intelligent scene recognition
- Lens shading compensation
- Coaxial communication
- Built-in Concealed Cable Bracket
- Weatherproof (IP67)



The lightning flash with an arrowhead symbol, within an equilateral triangle is intended to alert the user to the presence of uninsulated "dangerous voltage" within the product's enclosure that may be of sufficient magnitude to constitute a risk of electric shock to persons.



The exclamation point within an equilateral triangle is intended to alert the user to the presence of important operating and maintenance (servicing) instructions in the literature accompanying the appliance.

INFORMATION - This equipment has been tested and found to comply with limits for a Class A digital device, pursuant to part 15 of the FCC Rules. These limits are designed to provide reasonable protection against harmful interference when the equipment is operated in a commercial environment. This equipment generates, uses, and can radiate radio frequency energy and, if not installed and used in accordance with the instruction manual, may cause harmful interference to radio communications. Operation of this equipment in a residential area is likely to cause harmful interference in which case the user will be required to correct the interference at his own expense.









WARNING - Changes or modifications not expressly approved by the manufacturer could void the user's authority to operate the equipment.

CAUTION : To prevent electric shock and risk of fire hazards:

- Do NOT use power sources other than that specified.
- Do NOT expose this appliance to rain or moisture.

This installation should be made by a qualified service person and should conform to all local codes.

Precaution

	Do not Keep the camera face to strong light directly
	Do not install the camera in extreme temperature conditions.
	Do not disassemble the camera even if troubles happened
	To avoid malfunctions, never use the camera close to a gas or oil leak
	Do not drop the camera or subject them to physical shocks.
	Do not expose the camera to rain or spill beverage on it.
	Do not install the camera under unstable lighting conditions
	Do not install or use the camera in an environment where the humidity is high

1. Features

■ DEFOG

This camera supports DEFOG function which does a process of clearing blurred image caused by fog and snow by analyzing the brightness of input image and compensating the color of the image.

■ Horizontal Resolution

Over 700TVL with 960H CCD

■ DNR(Digital Noise Reduction)

- Improved "blur" of moving objects
- Fine color reproduction in low luminance

■ Low Light Performance

High sensitivity : Rich color information in even low luminance
Clear image under IR LED : Not saturated image by " IR optimizer"

■ IR Optimizer

Intelligent control for clear image under IR LED light

- PWM control for IR LED light
- Prevention of saturated image by AE
- Compensation of shading for IR LED hot spot

■ Real WDR (Wide Dynamic Range)

- Improvement of visibility under high contrast scene by double shutter and intelligent image processing
- Easy tuning for high contrast scene

■ Auto Scene Recognition

Provide the best image automatically for every situation
by intelligent scene analysis

■ Scene Selection

Provide the best image by automatic tuning for selected scene manually

2. Components

80units
(40 IR LEDs + 40 SRLEDs)

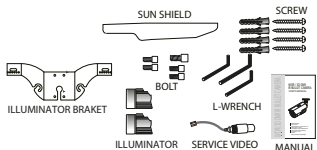
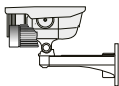

40 IR LEDs(w/o SR LED)

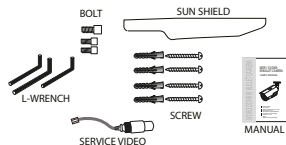
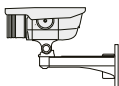

3. Names and Functions of Parts

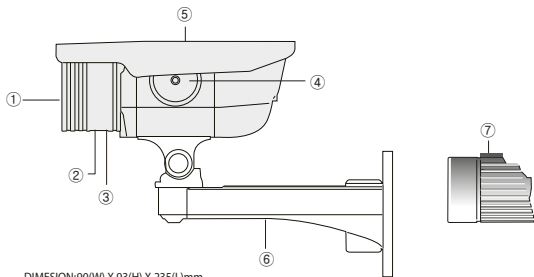

- ① IR LEDs
- ② Focus Handle
Used to provide for accurate of an object within the lens field of view
- ③ Zoom Handle
Used to adjust zoom magnification by turning
- ④ OSD Menu

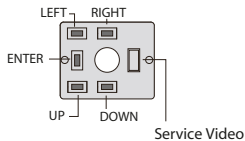

- ⑤ Sun-Shield
- ⑥ Bracket
- ⑦ Illuminator(Optional)

4. Installation & Connection

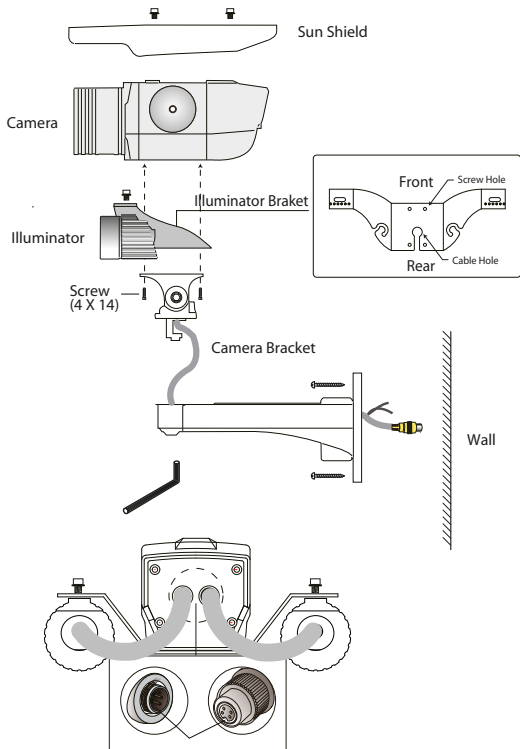

DC Power Connecting

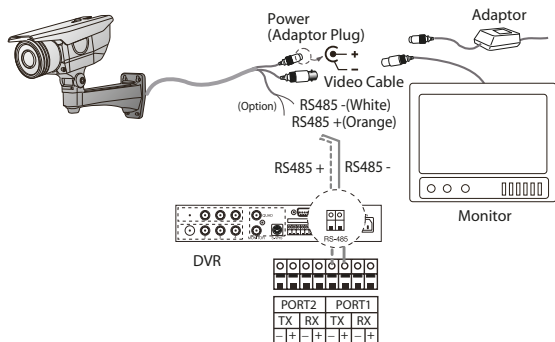

AC Power Connecting

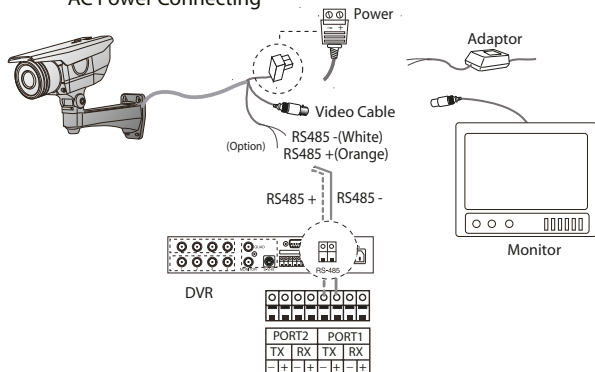

5. Setup Menu Flow

SETUP MENU		ADVANCED MENU		
SCENE SELECT	CUSTOM		FIX	SHUTTER
	FULL AUTO			AGC
	INDOOR		MANUAL	SHUTTER
	OUTDOOR			AGC MAX
	BACKLIGHT		AUTO	AE LEVEL
	ITS		AGC MAX	SENS UP
			ATW	SPEED
				DELAY CNT
				ATW FRAME
				ENVIRONMENT
			PUSH	
			USER1	B-GAIN
				R-GAIN
			USER2	B-GAIN
				R-GAIN
			ANTI-CR	
			MANUAL	LEVEL
			PUSH LOCK	
			OFF	
			HLC	CLIP LEVEL
			BLC	
			OFF	
			ATR-EX	CONTRAST
				CLEAR FACE
			WDR	CONTRAST
				CLEAR FACE
				LEVEL
			DAY	
			NIGHT	BURST
			AUTO	BURST
				CNTL SIGNAL
				DELAY CNT
				DAY → NIGHT
				NIGHT → DAY

ADVANCED MENU

IR OPTIMIZER	OFF			
	ON	MODE		
		IR AREA	TOP	
			BOTTOM	
			LEFT	
			RIGHT	
			WEIGHT	
		LEVEL		
		IR LED	OFF	
			FIX	LEVEL
			DAY/NIGHT	LEVEL MIN LEVEL MAX
	COLOR NIGHT	OFF		
		ON	COLOR GAIN	
	IR SHADE COMP	OFF		
ON		PATTERN		
		POSH POSV		
LENS SHD COMP	OFF			
	ON	PATTERN		
POSH				
POSV				
DEFOG	OFF			
	ON	LEVEL		
FLKLESS	OFF			
	ON	MODE		

SETUP MENU		ADVANCED MENU	
	BRIGHTNESS		
	CONTRAST		
	SHARPNESS		
	HUE		
	COLOR GAIN		
	MAG		
	PAN		
	TILT		
	AREA SEL		
	DISPLAY		
	POSITION		
	COLOR		
	TRANSP		
	MOSAIC		
	DETECT SENSE		
	INTERVAL		
	BLOCK DISP		
	MASK AREA		
	MOTION AREA	AREA SEL	
		AREA MODE	
		TOP	
		BOTTOM	
		LEFT	
		RIGHT	
		INT	
	SYNC MODE	LL	PHASE
		VSL	PHASE
		MANUAL	
	LENS	AUTO	TYPE
			MODE
			ADJUST
			SPEED

SETUP MENU		ADVANCED MENU		
SYS SETTING	FLIP			
	LCD/CRT			
	COMMUNICATION	PROTOCOL		
		ADDRESS		
		BAUD RATE		
		DATABIT		
		PARITY		
STOP BIT				
CAMERA ID	OFF			
	ON		POS	
LANGUAGE				
VERSION				
MAINTENANCE	W.PIX MASK	MANUAL	REGISTRATION	
			REG.POINT	
		CURSOR COLOR		
		BLINK		
		REG.NUMBER		
	AUTO	RUN		
	BACK			
	DATA CLEAR			
	CAMERA RESET			
EXIT	SAVE			
	NOT SAVE			
	CANCEL			
	BACK			

6. Dimension

unit : mm

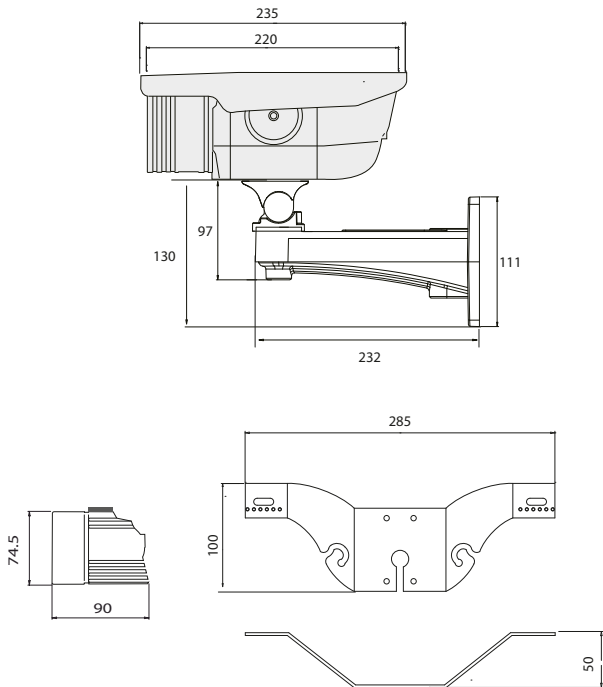

7. SPECIFICATIONS

TV System	NTSC	PAL
Sensor	Sony 960H Double Scan CCD II	
Total Pixels	(H)1020 x (V)508	(H)1020 x (V)596
Effective Pixels	(H)976 x (V)494	(H)976 x (V)582
Synchronization	H/V 15.734/59.94Hz	H/V 15.625/50Hz
Scanning System	2:1 Interlace	
Horizontal Resolution	700 TV Lines in color	
Min. Illumination	Color : 0.3 Lux	
	B/W : 0.1 Lux	
Video Output	VBS 1.0Vp-p (75ohm Terminated)	
S/N	More than 50dB	
Function		
Scene Select	Custom / Auto Scene / Indoor / Outdoor / Backlight / ITS	
Auto Gain Control	OFF / ON	
Shutter Speed	1/60~1/120,000	1/50~1/120,000
Digital Slow Shutter	OFF / AUTO (5X)	
Flickerless	OFF / ON / AUTO	
Wide Dynamic Range	OFF / MANUAL / AUTO	
Defog	OFF / ON	
BLC/HLC	OFF / ON	
Day & Night	DAY / NIGHT / AUTO / EXT 1 / EXT 2 (IR-Optimizer)	
White Balance	ATW / PUSH / MANUAL / USER 1 / USER 2 / PUSH LOCK	

Digital Noise Reduction	2D, 3D (OFF / 1~6)
Flip(Mirror)	OFF / H / V / HV
Effect	POSITIVE / NEGATIVE
Lens Shading Compensation	1 ~ 20 Steps
Polygon Privacy Mask	OFF / On (15 masks)
Motion Detection	OFF / ON (24 x 16 Block)
Blemish Compensation	MANUAL / AUTO (64 point)
Communication	COAX : PELCO-C / RS-485 : PELCO-D
Language	English / Español / Russian / Potugal / DEUTSCH / France / Japanese

Electrical

IR LED	IR LED 40 + SRLED 40 units	40 units
Night View Distance	Outdoor 120m	Outdoor 40m
Day & Night System	ICR	
Lens	6~50mm TDNDC Auto Iris Varifocal Lens	
Lens(Optional)	2.8~12mm DC Iris Varifocal Lens	
Operating Temperature/Humidity	-20°C ~50°C / 30% ~80%	
Storage Temperature/Humidity	-30°C ~60°C / 20% ~90%	
Power(Max.)	DC 12V 1200mA	DC 12V 550mA
	[Recommended-Voltage : +/- 20%, Current: Adapter with rated power of 2 times(than real using current)]	

Design and specifications are subject to change without notice

PRODUCT WARRANTY CARD

1) ITEM # :

2) S/N # :

3) INSTALLATION CONDITION

- Indoor / Outdoor

- Power supply SPECIFICATION :

DC12V / AC24V

CURRENT _____ mA

4) TROUBLESHOOTING

- No picture

- Bad image

- No power

- Water damage

- LED ON / OFF

- ETC. :

* Please keep this warranty card with the manual.

* Please fill out this warranty card and send us this warranty card with the faulty units together.

- Following cases can be charged even within the warranty period.
 - a. When defects are caused by user's carelessness.
 - b. When improper or unauthorized repairs are done or when the inside is modified or damaged.
 - c. Defects caused by natural disaster or power problem.
 - d. When the warranty card is not filled out or corrected unconfirmed.